

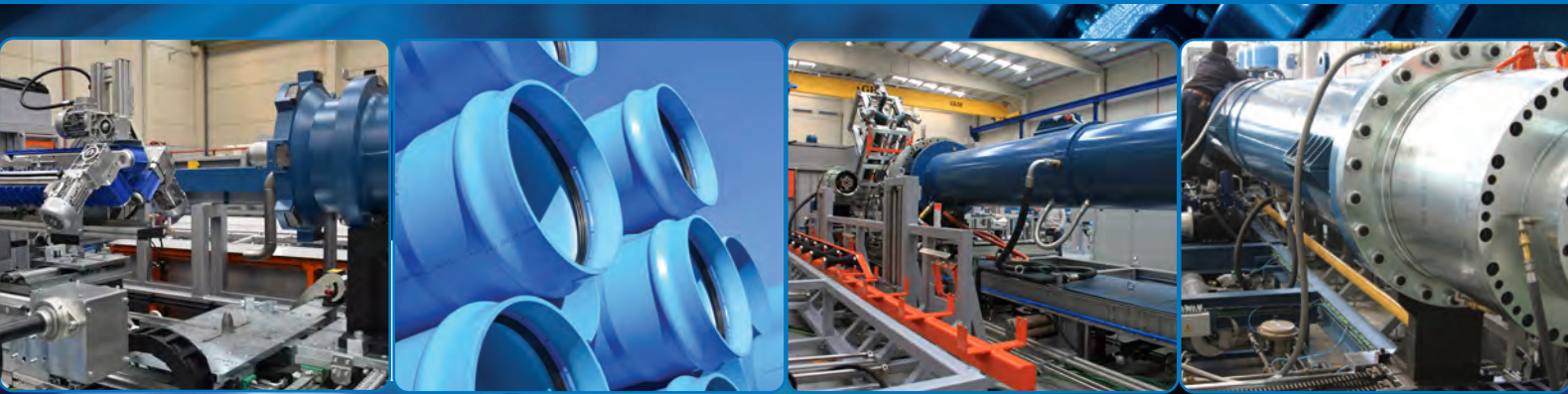

## The Genuine Air Technology to achieve the most of PVC-O pipes



Pushing limits beyond



Experience



Quality



Differentiated and innovative products



Range



Technical and commercial support



Logistics service

## Molecor, your partner for success in Molecular Orientation

**Molecor** is a Spanish company **specialized in infrastructure, sewage and edification solutions**, whose pipes and fittings are marketed in more than 30 countries around the world.

It was founded in 2006 with a focus on the development of Molecular Orientation technology applied to pressurized water pipes and since then its exponential growth and continuous improvement in the advancement of efficient and innovative solutions for the development of technology for the manufacture of Oriented PVC pipes, has made it the current world leader in the sector. In August 2020, the Spanish fund MCH Private Equity acquired a majority stake to provide Molecor with more strength to grow and develop its full potential, since in addition to the monetary contribution, MCH contributes with its industrial and financial expertise in both the organic and inorganic growth of the project. On September 30, 2021, Molecor completes the process of acquiring the production unit of Adequa (former Uralita Sistemas de Tuberías), adding to its portfolio of infrastructure solutions sanitation and edification to become one of the leading companies of pipes and fittings in Spain. In this way, it continues a great industrial project with a **strong focus on technology, efficient water use and internationalization**.

🔄 **Our purpose:** To improve the quality of life for people everywhere in the world, bringing affordable water within their reach through innovative, efficient and sustainable solutions.

🔄 **Our values:**

- **Nonconformism.** We seek to surpass previously achieved levels (quality, efficiency, innovation, safety, etc.) and we are not satisfied with what we have achieved.
- **Globality.** We are a global company, capable of offering our services and products anywhere in the world. To this end, we create an open, diverse and inclusive environment in which any talent can develop, regardless of nationality, location or origin.
- **Honesty.** We apply integrity at all levels in our relationships and decisions, within an environment of tolerance and respect. With transparency, but always respecting legality, regulatory limits and the principles of confidentiality and privacy.
- **Commitment.** We seek, value and are committed to the people around us, to the environment and to the communities in which we are present and in which we provide our services.
- **Attitude.** We like challenges and we are willing to face them actively, giving the best of ourselves, with maximum collaboration, flexibility, openness and sincerity.

### Research & Development

**Molecor** invests in R&D, intellectual property, as well as in human resources. Machine design, flow mechanics, heat transfer, materials and electronics are disciplines well covered at **Molecor** with its specialists. In addition to its valuable workforce, **Molecor** uses advanced and sophisticated design and calculus tools to provide always the latest and most advanced solutions.

### 100% Specialization

**Molecor** is dedicated exclusively to the development of the latest **technology applying Molecular Orientation** to PVC and to the implementation of **highly efficient solutions** for the conveyance of water under pressure.

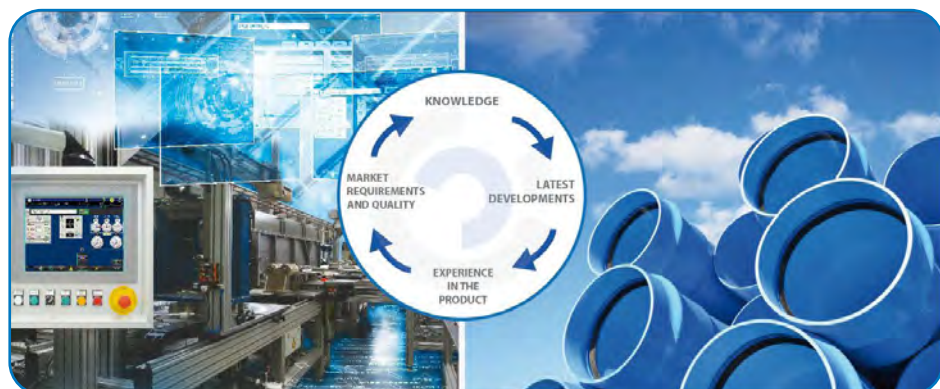

## Know-How

**Molecor**, specialized in the water under pressure sector, is not just a machine manufacturer or engineering company, but a pipe producer too. Currently, it **manufactures the widest range of products in PVC-O: pipes from DN90 mm up to DN1200 mm and from 12.5 up to 25 bar** as well as **PVC-O fittings from PN110 to DN400 mm in PN16 bar**.

## Exclusive products

Thanks to its worldwide unique technology, **Molecor** puts exclusive products available to the market. Among them we can find the **Integrated Seal System (ISS+)**, a 100% automatic system that inserts the gasket inside the socket, ensuring a perfect setting and achieving significant cost savings in manpower and maintenance. Besides this, we can highlight a wide range of products with pipes of up to **DN1200 mm** and the development of the **PVC-O fittings: ecoFITTOM®**.

## Molecular Orientation, the PVC revolution

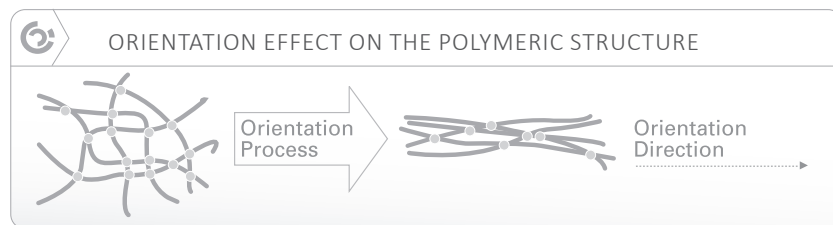

Molecular Orientation process modifies the PVC structure by giving the polymers molecules a specific orientation.

Molecular structure is the main feature that confers its mechanical properties to the PVC. PVC is a polymer which presents an amorphous molecular structure, where chains are arranged at random directions.

PVC-  
class 500

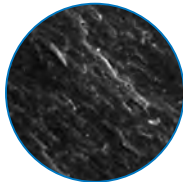

PVC-U

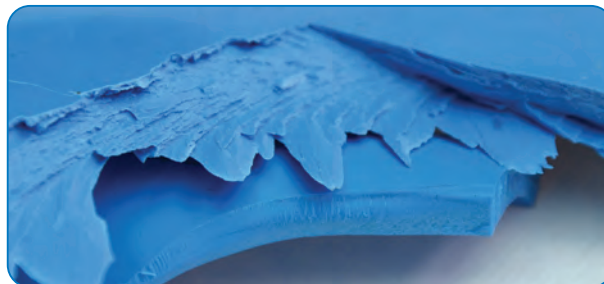
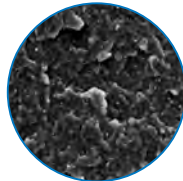

Data courtesy of BC Co. Polymer research and analysis. Jeol JSM-T-220-A Scanning Microscope

However, when stretching the material and under certain conditions of pressure, temperature and speed, the polymer molecules are aligned in the same direction as the stretching, resulting in a laminar structure.

## The result: the highest properties & the lowest costs

The **process of Molecular Orientation** greatly enhances the **PVC physical and mechanical properties**, maintaining the original polymer advantages. It becomes an unbeatable plastic in terms of strength, impact resistance and flexibility without altering its chemical properties.

When applied to high pressure pipelines, they become very resistant and have an **extremely long life expectancy**. Beside this, the pipe is **highly energy-efficient and environmentally friendly** during all its useful life because of the considerable savings in raw material and also the ease of installation.



## Hoop and axial orientation

The orientation degree defines the **PVC-O class**. The higher the class, the greater the orientation degree and the better mechanical properties achieved. The class is evaluated according to the long term hydrostatic strength test. The orientation is produced in the stretching direction. **Molecor's Technology system enables to attain orientation both in the hoop and axial directions, obtaining complementary benefits.**

**Hoop orientation** confers excellent qualities such as impact resistance and internal pressure resistance.

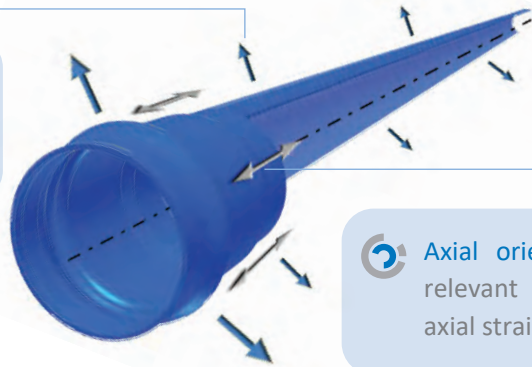

**Axial orientation** is particularly relevant in the socket, where axial strains could be produced.

## Long term hydrostatic resistance

Pipes are subjected to the internal pressure produced by the fluid circulation over a long period of time. The evolution in time of the material strength is known as creep, and appears to a far lesser extent in **PVC-O Class 500** than in conventional plastics, which means better long term performance.

**PVC-O Class 500** is the highest class recognized by the International Standard ISO 16422 and by the European Standard EN 17176, presenting **the best mechanical properties.**



### STRESS REGRESSION LINE

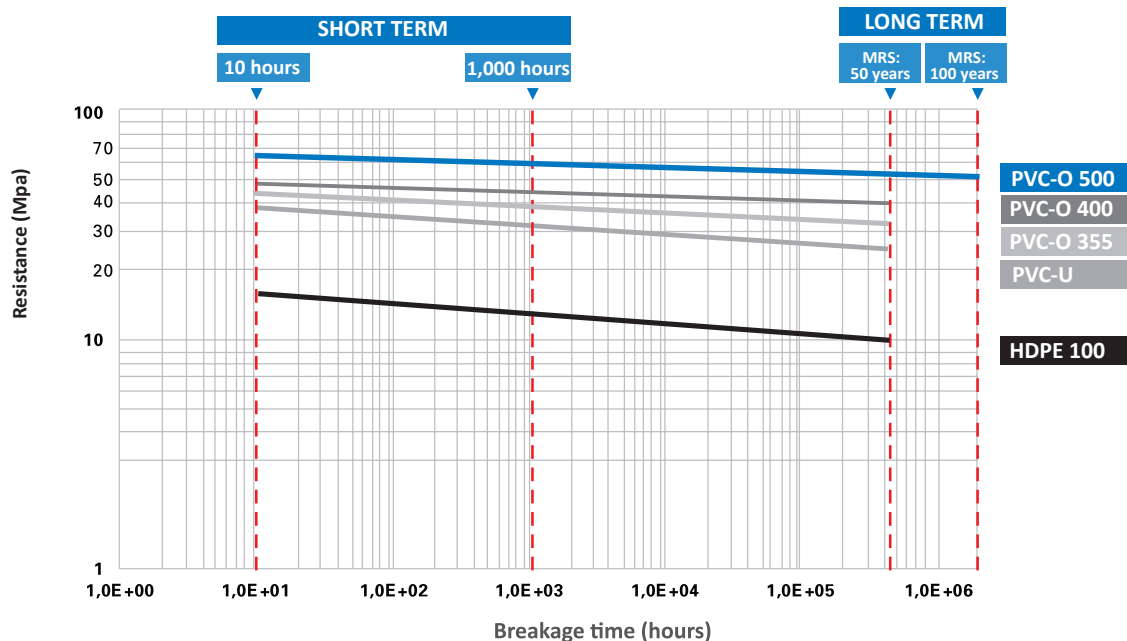



## Excellent short term performance

**PVC-O Class 500** pipes have a very different stress-strain curve when compared to other plastics and come very close to the curve of metals. The mechanical properties of PVC-O improve as the so called “creep valley” disappears. This phenomenon can only be achieved with the highest degree of orientation, **Class 500**.

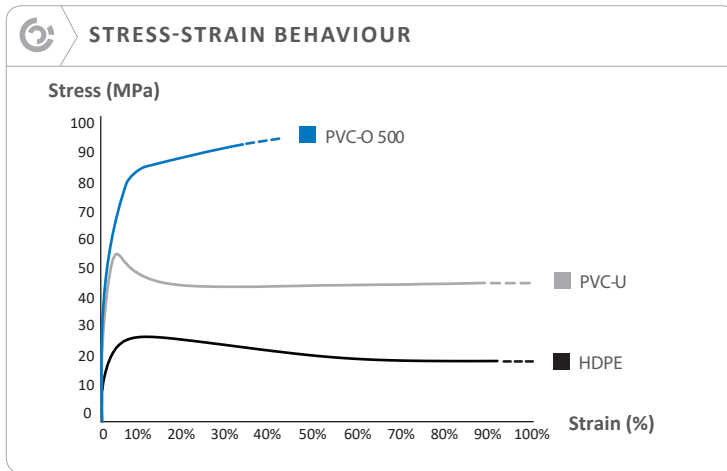

\* Circumferential tension values

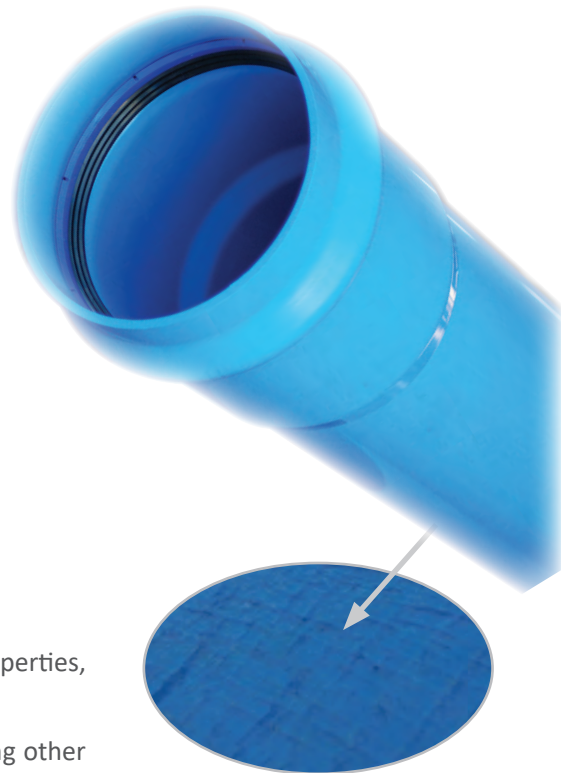

## Mechanical properties

**Molecular Orientation** increases the PVC-U pipe’s mechanical properties, obtaining a much more resistant and flexible pipe.

Impact resistance, no crack propagation and fatigue resistance, among other properties, are greatly enhanced without altering the chemical properties.

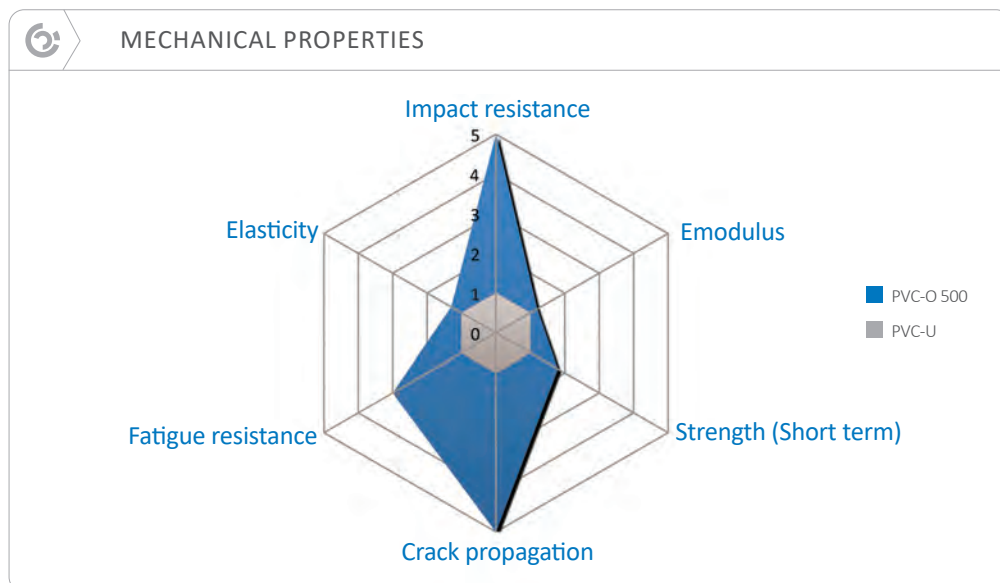

## Unbeatable impact resistance

**PVC-O Class 500** pipes are not easily destroyed by regular impacts. The risk of bursting during installation due to stone dropping or impact is minimal. The layered structure achieved with the Molecular Orientation process keeps from crack propagation and scratches.



**TOM**, PVC-O pipes of the maximum quality.  
Product guaranteed for 50 years.



Guarantee exclusively applicable to PVC-O pipes manufactured in the Loeches production center (Madrid) with AENOR Product Certificate No. 001/007104 in accordance with UNE-EN 17176: 2019.

## No crack propagation

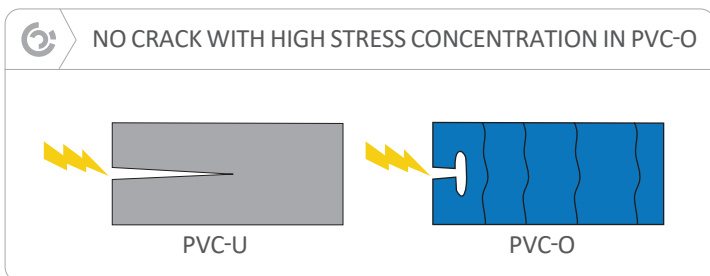

**PVC-O Class 500** laminar structure. Stress concentration is expanded over the layers surface preventing failure

The **layered structure** achieved with the **Molecular Orientation** process is the main feature which prevents from crack propagation along the pipe wall thickness. During installation, scratches caused by stones on site might be produced. When cracks appear, they progress through the amorphous wall structure. In **PVC-O Class 500** pipes, these cracks remain on the first layers, not affecting the pipe's properties at all.

## Absence of RCP

The phenomenon of rapid crack propagation (RCP) can take place under certain conditions of temperature and pressure. Brittle cracks can propagate along the pipe wall in the axial direction at a speed of 100 to 400 meters/second. The energy needed for this fast propagation is supplied by the fluid under pressure within the pipe. This phenomenon, very common in some pipes, is **minimized in PVC-O pipes** due to the material's nature.

## High short and long term hydrostatic resistance

**PVC-O Class 500** pipes offer a **resistance to internal pressure up to two times the nominal pressure**, which means that they can bear a sporadic excess of pressure such as water hammers in the network. The durability of the pipe working at nominal pressure is ensured thanks to the low material creep behavior for over a hundred years.

## Increased hydraulic capacity

**PVC-O Class 500** widens the pipe's internal diameter and flow section. Besides, the perfect finishing on the internal surface makes it extremely smooth, minimizing load loss and making it more difficult for deposits to be formed on the inner walls. As a result, **PVC-O Class 500** pipes offer **between 15% - 40% more hydraulic capacity** than pipes made from other materials (PVC-U, HDPE, ductile iron) with the same external dimensions.

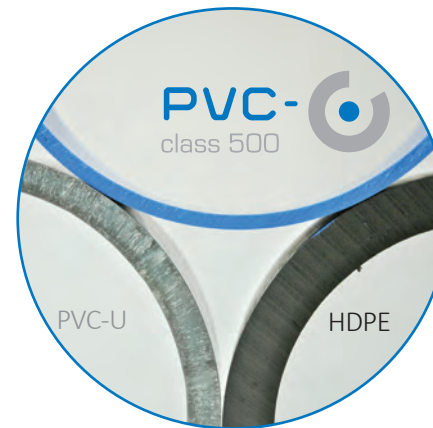

## Maximum ductility



**PVC-O Class 500** pipes can **bear big deformations of their internal diameter** thanks to their excellent ductility. When crushed, or in the event of a mechanical accident, they immediately recover their original shape, thus eliminating the risk of potential breakage by soil subsidence or sharp edges on rocks or machinery.

## Excellent behaviour to extreme working temperatures

 **Hot:**  
up to 45° C

 **Cold:**  
down to -40° C

In general, the plastics capacity to absorb impacts is very much more related to temperature. Below -10°C, plastics can present a brittle behavior which makes them inappropriate for cold climates. **PVC-O Class 500** does not present significant variations in its capacity to absorb impacts even in the most extreme cold areas of the world.

## UV Radiation

UV radiation promotes micro cracks on the PVC-U surface and another plastic pipes exposed to sunlight over a long period of time. These cracks propagate through the plastic pipe's wall thickness. **PVC-O pipes' layered structure** blocks them, so they remain on the external layer. That is why the pipe's behavior is not affected. Tests carried out with PVC-O pipes exposed to sunlight during a period of more than a year have shown an equivalent response than those non exposed to UV.



## Corrosion resistance

**PVC-O Class 500** is **immune to the corrosion** caused by natural substances in the soil or agricultural chemicals. Therefore, it is not degradable and does not require any special protection or coating solution, which is translated into cost savings. The quality of the conveyed fluid remains always unaltered, since there is neither corrosion of the material nor migration within the pipes or on their coating. Mandatory tests show compliance with the required health standards for water human consumption.





## Molecor: TOM®

**TOM®** is the registered trade mark for **Molecor PVC-O Class 500** pipe. Due to the outstanding properties of these pipes, **Molecor** has become, within a brief period of time, a referent in the water sector. **Molecor** manufacturing plant follows an Integrated Quality and Environment Management System based on the **UNE-EN ISO 9001** and **UNE-EN ISO 14001** standards, for the “Manufacture of PVC-O Pipes for conveyance of fluids under pressure.”

**TOM® PVC-O pipes** are manufactured according to the Spanish Standard **UNE-EN 17176:2019**, based on the International Standard **EN 17176**, and the International Standard **ISO 16422:2014**, having achieved the corresponding product certificates or quality marks.

### Lower installation costs

**PVC-O 500 pipes** are **lighter** and **easier to handle** than pipes made of other materials. In fact, no machinery is required to handle pipes up to DN315 mm. In addition, their **lightness**, **ductility** and **resistance to impact** have a direct impact in terms of greater profitability, performance and speed in installation compared to other types of pipes.

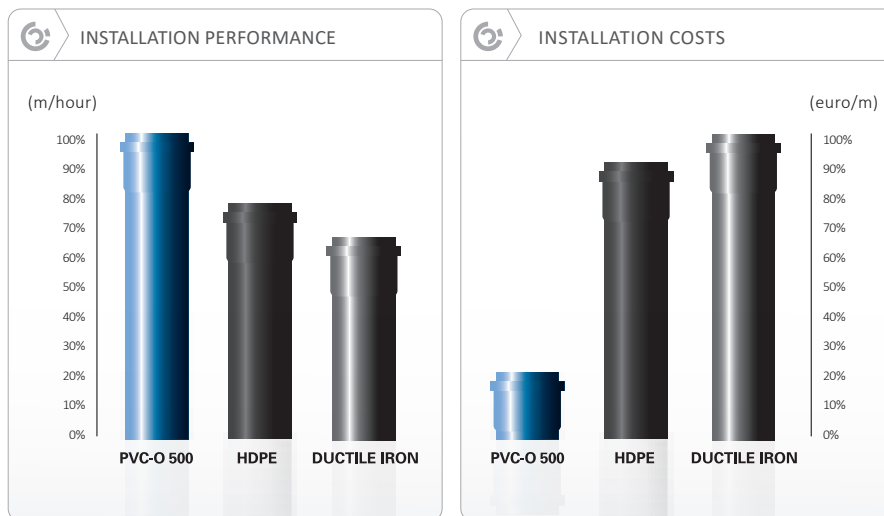

Charts figures for DN200-250 mm PN16 bar pipes



### Lighter pipe: easy to handle, fast to connect

**PVC-O Class 500** pipes **weight less than half the usual weight of PVC and HDPE**, and are **between six and twelve times lighter than ductile iron pipes** of the same diameter. They are **easy to handle** and they can be lifted without mechanical assistance (for pipes up to DN315 mm). During the installation process, the **connections between pipes are faster** and there is no need for welded unions thanks to the pipe's design and the PVC-O Class 500 properties. Besides, due to the **PVC-O Class 500** toughness, the scratches caused by impacts are minimal and pipes present many advantages when unloading and burying.

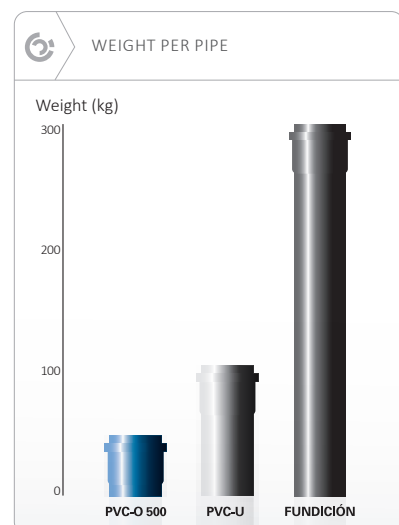

ISO 16422. For a 6 m pipe DN250 mm PN16 bar

## Applications



### Supplying (blue TOM®)

Conduits for **potable water** transport. This includes water extraction, water distribution network to city centers and industrial areas, and water transfer to tanks and reservoirs.

### Irrigation (blue TOM®)

Pipes for transporting water intended for **irrigation**. It includes both conduits to irrigated areas and distribution to plots and within the plot as well as drives to tanks, ponds and reservoirs.



### Reclaimed water (purple TOM®)

Pipelines for the transport of **water that has been treated** to remove impurities.

### Other applications

- Sewage
- Fire Protection Nets
- Industrial Applications
- Infrastructural Nets

## Fittings

**TOM® pipes** are compatible with all kinds of ductile iron fittings (T, elbows, etc) saddles and flanges.



**Tapping saddles** allow connecting the pipe in the perpendicular direction to all kinds of fittings, being available with screw ends and flange ends.



**Fittings with euro type plugs** are connected directly to the pipe allowing for deviations, reductions and connections on the net.



**Flanges with anti-traction system** allow connecting the spigot ends to all kinds of fittings with connection to a flange.

## Certifications

**PVC-O pipes** manufactured with Molecor Technology are certified according to the following standards:

UNE-EN 17176  
N Mark  
(Spain)



ISO 16422  
N Mark  
(Spain)



NF T54-948  
NF \* Mark  
(France)



SANS  
16422  
(South Africa)



AS/NZS 4441  
SAI GLOBAL  
Mark  
(Australia)



ISO 16422  
INEN Mark  
(Ecuador)



NTC 5425  
ICONTEC  
Mark  
(Colombia)



ISO 16422  
SIRIM Mark  
(Malaysia)



GOST R 56927  
FOCT P 56927  
(Russia)



NTP - ISO  
16422\*  
(Peru)



NP - ISO  
16422  
(Paraguay)



SNI ISO 16422  
SNI Mark  
(Indonesia)



# ECO FITTOM

ecoFITTOM®, the first fittings in the world in PVC-O, present excellent improvements in the mechanical properties of PVC. These improvements allow to manufacture ecoFITTOM® optimizing the consumption of raw material and less energy obtaining a product with higher hydrostatic resistance and higher resistance to impact than fittings of other materials. Besides this, ecoFITTOM® presents an excellent behavior against water hammer, complete watertight, maximum chemical resistance and ductility.

With ecoFITTOM® Molecor offers a continuous system in PVC-O; this material continuity guarantees the same hydraulic and mechanical properties in the different elements of the network, in the pipes as well as in the fittings.

These fittings can be used in networks for the transportation of drinking water, irrigation systems, industrial applications, sewage, infrastructure networks, fire protection nets, etc. among other applications.



## Process for obtaining PVC-O fittings

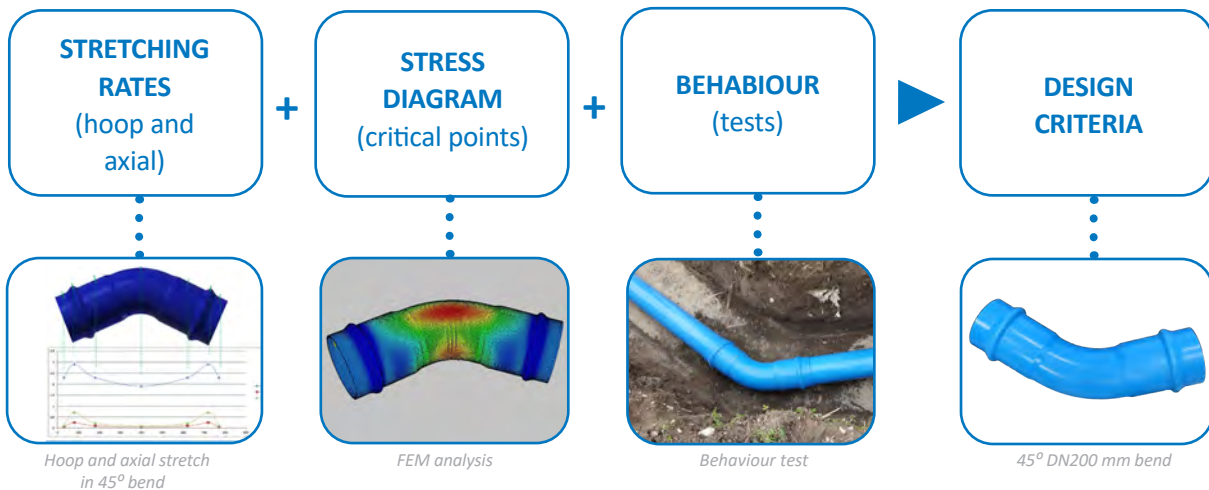

## Manufacturing system

The technology used for manufacturing the ecoFITTOM® PVC-O fittings is based on the technology used for the manufacture of TOM® pipes. It consists of a **Genuine Air System** that ensures higher efficiency and control of the molecular orientation parameters throughout the entire process.

This use of air during the whole process, instead of boiling water as used in other manufacturing processes, guarantees a high degree of security to the operators since it protects them from burns in the event of leakages and avoids the formation of sliding surfaces eliminating potential risks and guaranteeing complete security and reliability of the technology.



The energy used in the manufacturing process of **ecoFIT TOM®** is applied to the fitting by a specific air distribution that allows the optimization of the resources, since it uses the lowest amount of energy possible obtaining the maximum performance.

In addition to this, the system allows the use of reprocessed material in the manufacturing of the **PVC-O fittings ecoFIT TOM®** which are subjected to exhaustive quality tests once the production process is finished.

The **ecoFIT TOM® PVC-O fittings**, manufactured in PN16 bar, present excellent improvements in the mechanical properties of PVC-O. These improvements allow to manufacture **ecoFIT TOM®** consuming less raw material, contrary to what happens with fittings made of other materials with the same working and pressure requirements. These fittings are manufactured according to the Spanish PVC-O Standard **UNE-CEN/TS 17176:3**, based on the International Standard **EN 17176**, and have the **AENOR Product Certificate No. 001/007103** in accordance with the standard **UNE-CEN/TS 17176-3: 2019**. Mark 

In this way, **ecoFIT TOM®** becomes one of the **most efficient and sustainable products and with a higher lifecycle** in the field of the fittings applied for the conveyance of water under pressure.



## Advantages



### Cost-efficiency



### Environmental advantages



### Installation advantages

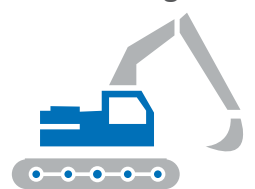

Currently **Molecor** offers a wide range of fittings from DN110 mm to DN400 mm in PN16 bar:

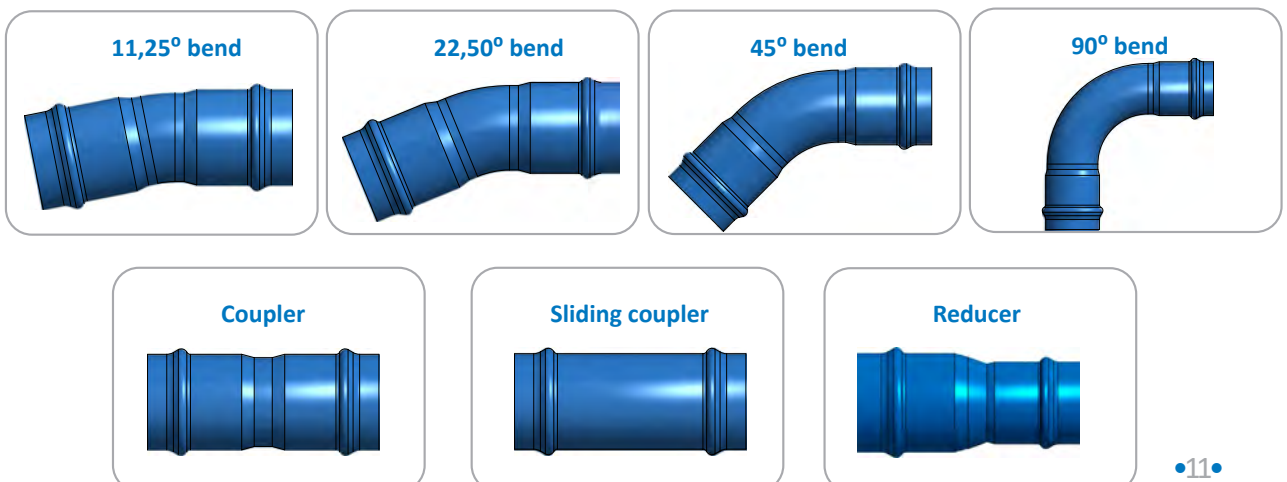

## The most eco-friendly solution for water transportation

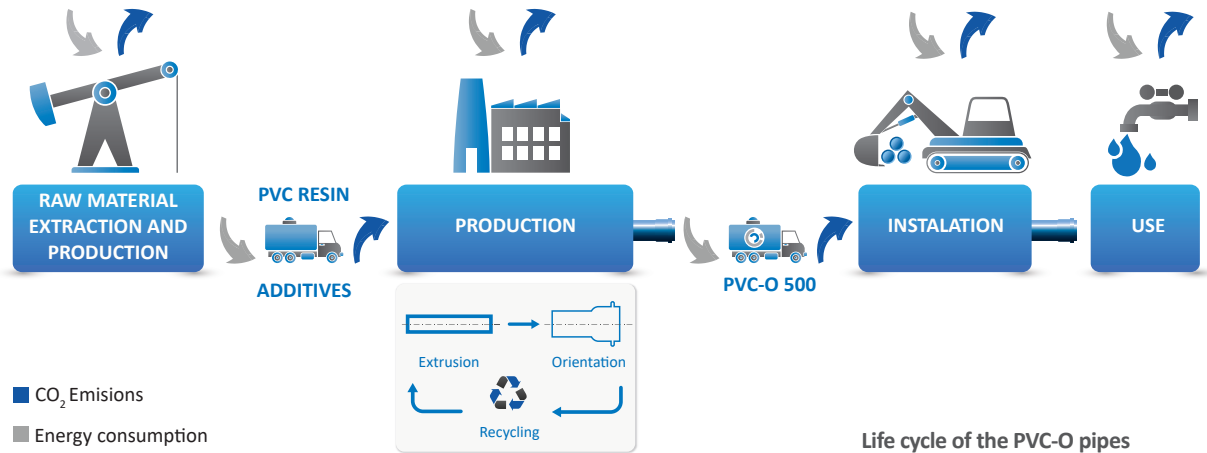

The environmental impact of a piping system depends on its composition and on the application thereof, being the kind of material used, the manufacturing process, the high quality of the finished product and its useful life, the main factors that determine the efficiency and sustainability throughout all its life cycle.

**Class 500 TOM® PVC-O pipes** are the most ecological solution in the market, as many worldwide studies have demonstrated, due to their better contribution to a correct sustainable development of the planet, presenting environmental advantages during all their life cycle.



### Efficiency in resources

Embodied energy is defined as the non-renewable energy consumed in all the activities associated to the pipe's life cycle. This lifecycle includes raw material extraction, manufacture, installation and other supporting functions, such as transport.

The exceptional mechanical properties of the **TOM® pipes** allow very important savings in raw materials. Only 43% of PVC composition depends on oil. Therefore, the consumption required of this resource for their manufacture is lower compared to other plastic solutions.

The energy consumption required by the Molecor Technology is not only lower than the required by pipes made of other materials, but also compared to the required by other **PVC-O pipe's production processes**. The lower consumption of raw materials results in **energy savings** during the extraction and the material production. It is also a key factor during conveyance and installation: their lower weight makes the installation process quicker and easier.

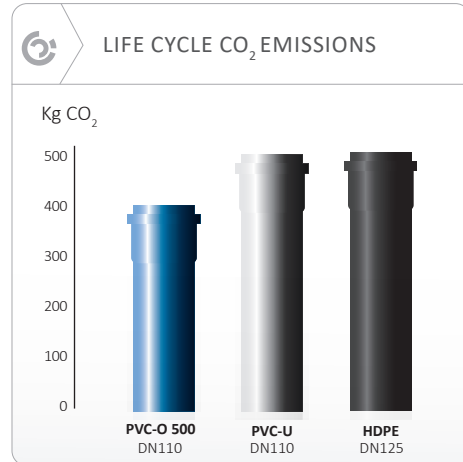
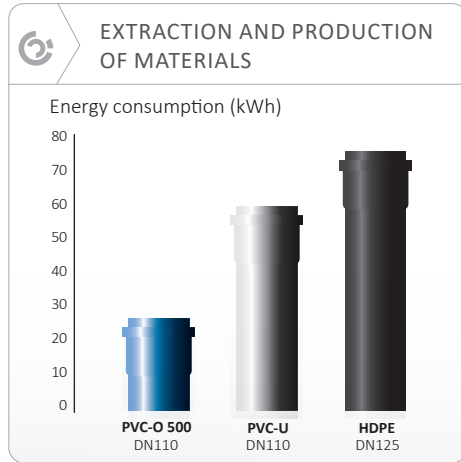

“ESTIMATION OF ENERGY CONSUMPTION AND CO<sub>2</sub> EMISSIONS DUE TO PRODUCTION, USAGE, AND FINAL USAGE OF PVC, HDPE, PP AND CAST IRON PIPES”. Department of Engineering Projects. Universitat Politècnica de Catalunya. Barcelona. Requested by Foro Iberico del PVC.

Water networks manufactured with traditional materials, currently register a percentage of channeled water leakages up to 25%. Moreover, chemical deterioration makes some canalizations to be replaced few years after having being installed.

**PVC-O Class 500 pipes** inner walls are extremely smooth, what minimizes head losses. Hence the energy needed for the conveyance is lower, avoiding an unnecessary consumption of energy resources and reducing CO<sub>2</sub> emissions into the atmosphere.

The Molecor Technology is committed to the reduction of the greenhouse effect. **Class 500 PVC-O pipes** reduce CO<sub>2</sub> emissions in every link of its lifecycle chain and are, therefore, a tool for managing water resources for the generations to come. **PVC-O Class 500 pipes** avoid unnecessary energy consumption throughout their long lifecycle.

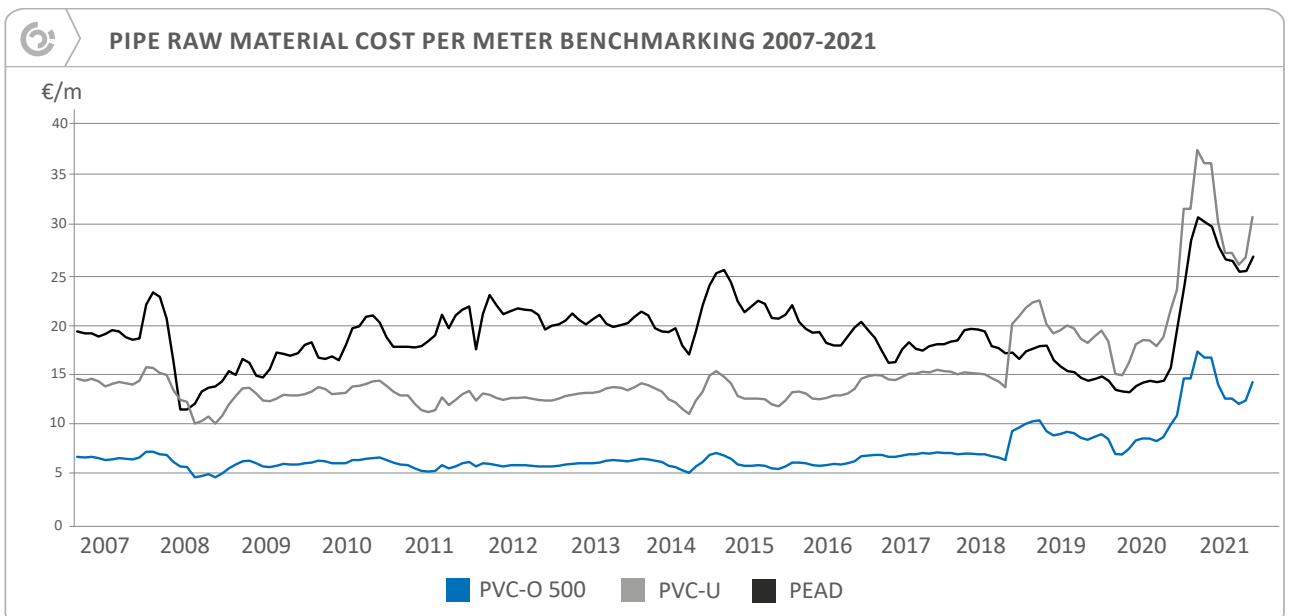

ISO 16422. Data for a DN250 mm PN16 bar pipe



## Hydraulic capacity

The reduction of raw materials consumption is a common international goal in the field of sustainable development.

The spectacular **PVC-O Class 500** properties, thanks to Molecular Orientation, imply **less material** per pipe and consequently, a **reduction in the associated costs**.

Water pipes not only have to be pressure-resistant, but they also have to transport the highest amount of water while consuming the least amount of energy.

**PVC-O Class 500 pipes** walls are thinner than those of conventional plastic pipes and smoother than those of metal pipes, which means greater hydraulic capacity.

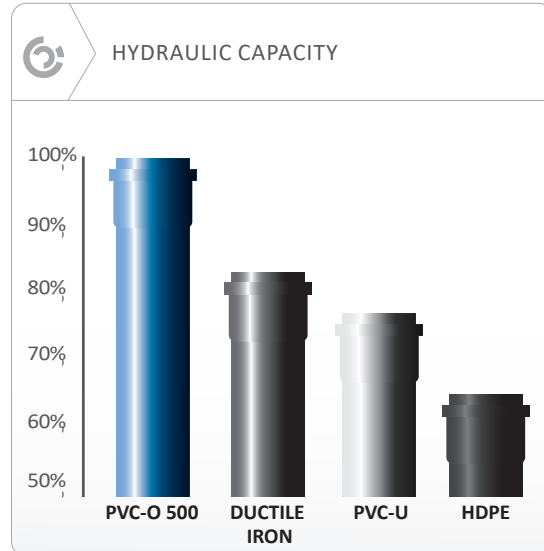

ISO 16422. For a 1m DN250 mm PN16 bar

## Efficiency in resource management

**PVC-O 500 pipes** are **100% recyclable**. They can be ground and processed as rework material to be used in pipe production again or in the manufacturing of other plastic products, without losing any of their properties.



## Sustainability

**TOM®** is a sustainable pipe in which design the environment preservation has been taken into account considering aspects as: energy saving, sustainable use of natural resources, constructions durability and respect to environment.



**MolecOR** has evaluated **TOM® pipes environmental impact** in all the stages of their lifecycle following the 179/2013/CE Recommendation, the last common calculation methodology proposed by the European Commission for the study of the **Product Environmental Footprint (PEF)**. That is to say, from the raw material extraction to the final product, including the manufacturing process, their distribution and their different applications.

According to this, the effect that **TOM® pipes** caused in 14 environmental impacts has been estimated.

- **Air and atmosphere:** climate change, acidification, depletion of the ozone layer and formation of photochemical ozone.
- **Water:** resource depletion (water), fresh water ecotoxicity and water eutrophication.
- **Soil:** resource depletion (minerals), land eutrophication and the use of the ground.
- **Human health:** respiratory inorganic elements, ionizing radiation, effects on human health (carcinogenics) and effects on the human health (no carcinogenics).

Environmental impacts	Absolute	
Climate change	8.3E+01	kg CO2e
Ozone depletion	5.3E-06	kg CFC-11e
Ecotoxicity – aquatic, fresh water	1.8E+02	CTUe
Human toxicity – cancer effects	4.8E-06	CTUe
Human toxicity - non-cancer effects	8.6E-06	CTUh
Particulate matter / Respiratory inorganics	1.3E-02	kg PM2.5e
Ionising radiation – human health effects	5.3E+00	kg U235e
Photochemical ozone formation	4.1E-01	kg NMVOC
Acidification	4.1E-01	mol H+e
Eutrophication - terrestrial	1.0E+00	mol Ne
Eutrophication – aquatic, fresh water	1.6E-03	kg Pe
Eutrophication – aquatic, sea water	9.5E-02	kg Ne
Resource depletion – water	1.9E-01	m <sup>3</sup> SWU
Resource depletion – mineral, fossil	3.8E-03	kg Sbe
Land transformation	1.6E+02	kg Cdef

Class 500 TOM® PVC-O pipes environmental footprint according to Recommendation 179/2013/EC

The Carbon Footprint is the best known environmental parameter. It takes into account the emission of greenhouse gases into the atmosphere, known as CO<sub>2</sub>, which are the responsible of the current climate change.

**TOM® pipes** are provided with the Huella Ambiental FVS ecolabel, promoted by the “Fundación Vida Sostenible” and the Working and Social Safety Ministry’s company’s responsibility.



## The Genuine Air System

- Efficiency and cleanness: easy maintenance, start-up and diameter change
- Safety: the absence of boiling water prevents from leakage risks
- Cost effectiveness: energy is applied to the pipe throughout specific air distribution

## Integrated Socket System

- Socket is conformed at the same time as orientation takes place
- No orientation degree loss guaranteed
- No extra maintenance, time for changing, etc.

## In line process

- Minimum labor and maximum effectiveness are achieved
- Standard factory lay-out
- Shortest line length even for the biggest pipes

## Widest range of products

- DN: from 90 mm to 1200 mm (4" to 48")
- PN: up to 25 bar (365 psi) / 305 psi (21 bar)
- Compliance with worldwide standards
- Special projects for larger diameters





## Flexibility in the process



- Designed to work in line or in batch, small pipe batches may be produced if required by market demands
- Capability of producing "Taylor-made pipe solutions" under client's request



### Highest orientation degree: up to Class 500



-  The best mechanical properties
-  Maximum material savings
-  The real guaranty for competition, being the best and the cheapest at the same time

### Stability



-  Easy and fast start-up, less than one hour
-  Normal production with recycled material at any percentage
-  Independent extrusion and orientation processes, disconnected to avoid collapse in the whole line when singular failures in production occur

### Integrated Seal System





-  100% Automatic system
-  Reinforced rubber gasket
-  Excellent mechanical properties in the socket

### Fully automated process: recipe system

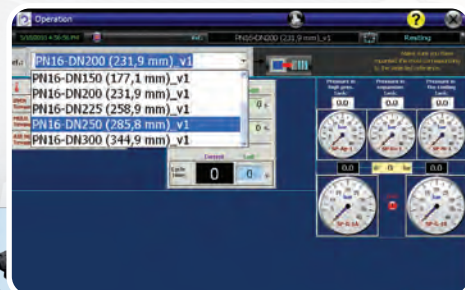
-  Easy manufacturing
-  Logic intuitive control for the operator
-  Low learning curve



### Technical support

-  Remote internet assistance
-  Immediate technical support

## Molecor socketing system features

The socket is the most important part of the pipe. Socket geometry is more complex than in the rest of the pipe, and stresses are higher, mainly in the axial direction. Moreover, its extra dimension compared to the barrel makes of it a more exposed element to impacts, scratches and other damages during installation.

**Molecor** has researched all aspects surrounding the correct way of working of a rubber ring socket union, in order to design **the best system for a PVC-O pipe**. The mechanical and geometrical parameters of a socket need to be considered. However, the aspects related to the orientation process, commonly underestimated, are the real issue for a proper PVC-O pipe equipment design.

### Fundamentals of a proper socketing system for PVC-O

The socket's objective is the union between pipes **ensuring leak tightness** and enabling a **quick and easy installation** on site. Sockets have to be designed so as to provide mechanical resistance. The socket's design in PVC-O pipes do not only depend on certain geometry criteria or thickness distribution. Sockets are expected to maintain the excellent properties attained during Molecular Orientation. For that reason it is important to attain the right orientation degree on each part of the socket, since it is known how stresses are different along the different sections of the socket.

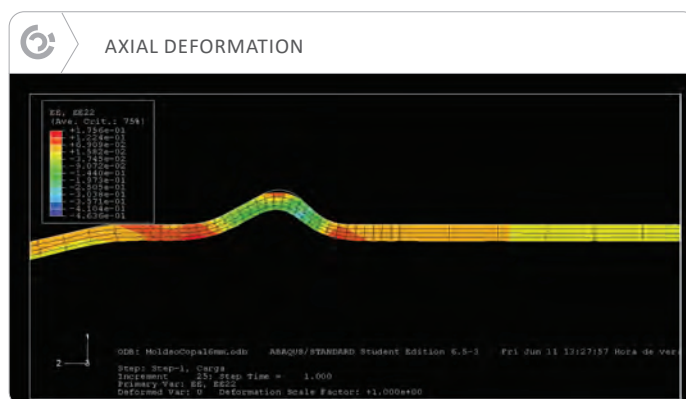
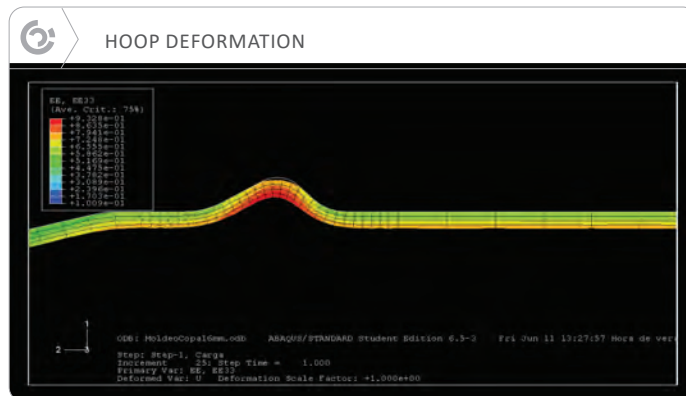

FEM simulation of a PVC-O pipe behaviour with axial and hoop orientation

## Socket design improvements

**Molecor** has enhanced the classical socket shape to give it **extra security with an extra large depth of engagement** to enable a safer installation. **Molecor** special design includes an open lip with a bell shape that improves the pipe's assembly process. Furthermore, Molecor provides local orientation to reinforce the stress concentration areas.

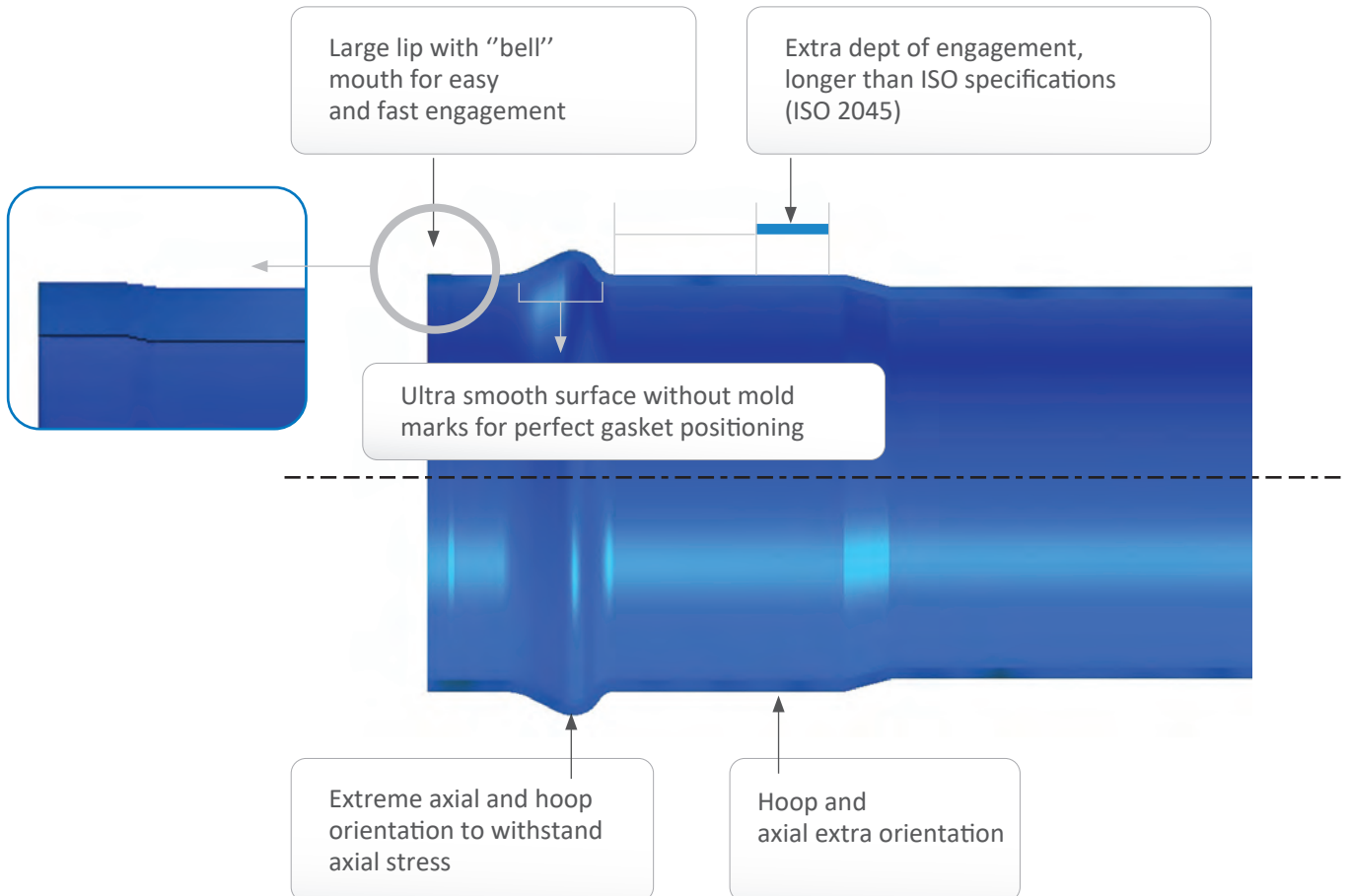

## Smooth air molding

Socket shaping is done with air, thus avoiding marks of mold unions and scratches on the inner surface, which provides perfect leak tightness and very easy gasket positioning.

## Integral socket

In opposition to other existing systems, **the technology of Molecor produces the socket at the same time as the rest of the pipe to achieve the optimum conditions for Molecular Orientation.**

Therefore, there is no secondary process of reheating and reorientation which could result in a degradation of the properties. In addition to the process simultaneity and stability, **Molecor's** patented technology allows for different degrees of orientation in the required sections of the socket and for specific wall thickness distribution. In any case, it can be adapted to external machinery devices specially designed for socketing PVC-O pipes.



## M-OR-P 5012, technology to manufacture the largest PVC-O pipe in the world: DN1200 mm

Molecor has developed the first system in the world able to manufacture PVC-O pipes from diameter DN500 mm (18") up to DN1200 mm (48")



In 64 meters length it includes the extruder, the vacuum tank, the spray tank, the haul off, the saw and the orientation equipment. It incorporates an exclusive innovation: an initial tube discard system that guarantees 100% the quality of the manufactured pipes. This machine is really an innovation in the technological sector of the oriented pipe industry.

### Technical Characteristics

This is the system with the highest production capacity that Molecor offers, being able to manufacture 1,100 kg/h. It is compatible with standard designs of plastic pipe factories and **it can work with a preform pipe up to 750 mm diameter and 2000 kg.**

One of the most characteristic and differentiating element, in comparison with other systems, apart from its dimensions or manufacturing possibilities, is its **industrial programming**. This system has been developed for the **M-OR-P 5012** exclusively. This is the only machine whose working process is 100% robotic and automatic.

DN 1200 mm

-  Hydraulic overrides that make easier the orientation tools movement.
-  A warming system wich works by forced air convection, monitorized in up to ten different zones during the heating process of the PVC-O pipe inside the oven.
-  An integrated weighing system that confirms the viability and quality of the tube in the finishing process.

#### Energy efficiency



Energy is applied only in the pipe by specific air distribution.

#### Stability

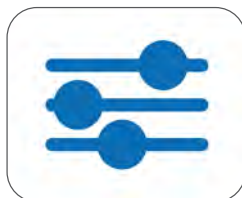

The Genuine Air System prevents leakage risks due to the absence of boiling water.

#### Security and quality



Power outages do not cause stops all along the whole line.

#### Production



In-line work at the same speed as the extruder. No intermediate stocks.



## A new machine in line with Molecor's 360° Support Policy

As a world reference in **Molecular Orientation**, Molecor provides the necessary support and expertise for a sustainable growth in order to achieve the project success. That is the reason why the new development of the technology count on a monitoring and control system helped by an industrial computer in order to obtain detailed data on its production and maintenance.

### Applications



**PVC-O pipes** are the most advanced solution for the conveyance of water under pressure on the market, this new development increase the diameters range available wich are impossible to manufacture with other systems. This quality makes them the best option for drinking water distribution networks, absorption systems in lakes or dammings, desalination, irrigation and other important municipal or state projects.

### Integrated Seal System (ISS+)



Molecor has developed a system, patent pending, to manufacture **PVC-O pipes** with **Integrated Seal System**. The joining of PVC-O pipes is achieved by means of a rubber sealing ring placed on the pipe socket to effectively prevent leakages between two joined pipes after the spigot (male end) is inserted into the bell (female end).

Molecor has implemented an **Integrated Seal System** in order to introduce a reinforced rubber gasket inside the pipe right after orientation, keeping the excellent mechanical properties of PVC-O pipes especially in the socket.

#### Steps:

1- Gasket Positioning

2- Heating up

3- Cooling down

4- Extraction

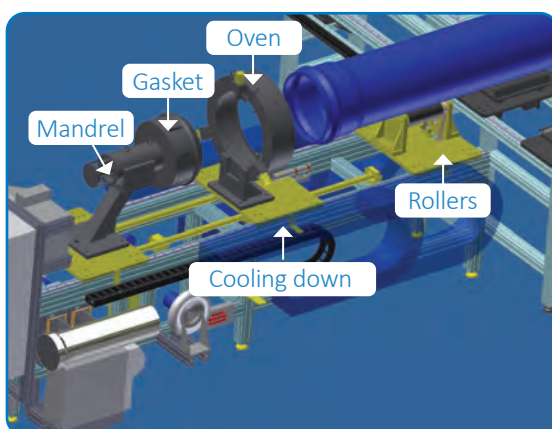

The **Integrated Seal System ISS+** applied to **PVC-O pipes** presents improvements in the pipes behavior, especially in larger diameters and high pressures. Up to now, this technology had not been applied to PVC-O pipes.

- 100% Automatic system
- Reinforced rubber gasket
- Mechanical and electrical security systems
- Fail-Safe concept
- Excellent mechanical properties in the socket

## Worldwide regulations support

PVC-O pipes manufacture is worldwide supported. There is an International Standard as well as national Standards in USA, France, South Africa, Australia/NZ, Spain, Canada, Brazil, Colombia, Saudi Arabia, Peru, UK, India, Paraguay, Japan, Morocco, Turkey, Russia, Japan and Indonesia.

HIDRAULIC DESIGN							
	Standard	CLASS	$\sigma_s$	Cs	HDB (psi)	(MPa)	MRS (MPa)
AENOR	EN 17176:2019						
	ISO 16422:2014						
AENOR	UNE-EN 17176:2019						
BSI	BS-ISO 16422						
AENOR	SANS 16422						
Indecopi	NTP-ISO 16422	500	36-32-25	1,4-1,6-2			50
	SASO-ISO 16422	450	32-28-23	1,4-1,6-2			45
TSE	TS ISO 16422	400	25-20	1,6-2			40
INEN	NTE - INEM -ISO 16422						
	NP-ISO 16422						
BSN	SNI-ISO 16422						
CG	GOST R 56927						
IMANOR	NM-ISO 16422						
	BIS 16647 : 2017	450-500	28-36	1,4-2			45-50
STANDARDS	AS/NZS	500	32				50
	4441:2008	450	28	1,6			45
		400	25				40
ASTM	ASTM F1483-12	PVCO 1135	24,46 (3.550 psi)	2	7.100	48,92	42,6 (stim)
	AWWA C909-09		24,48 (3.550 psi)	2	7.100	48,95	42,6 (stim)
CSA	CSA 137.3.1-09		24,48 (3.550 psi)	2	7.100	48,95	
Icontec	NTC 5425	PVCO 1139	26,9 (3.900 psi)	2	7.490	51,64	42,6 (stim)
		PVCO 1135	24,46 (3.550 psi)		7.100	48,92	
ABNT	ABTN NBR 15750		25				45
			28	1,6			40
afnor	AFNOR T54-948	500	40	1,6			50
		450	36				45
		400	25	1,25			40

**NF** Mark for DN90 to DN500 mm in PN16, DN110 to DN500 mm in PN25.

### Orientation degree: Class

The material class is defined by the material behavior in the long term test. The higher the class achieved, the better the mechanical properties attained. There are three main classifications, the International Standard, the American Standard and the European Standard. As reported by the International Standard, ISO 16422, and to the European Standard, EN 17176, the **PVC-O Class 500** is the highest. It is based on the ISO 9080 test conducted at  $10^4$  hours and extrapolated to 50 years. For **PVC-O Class 500** the MRS (Minimum Required Strength) is at least 50 MPa in 50 years, whereas for example for the class 400 the nominal test pressure minimum value is 40 MPa.

STRESS REGRESSION LINE

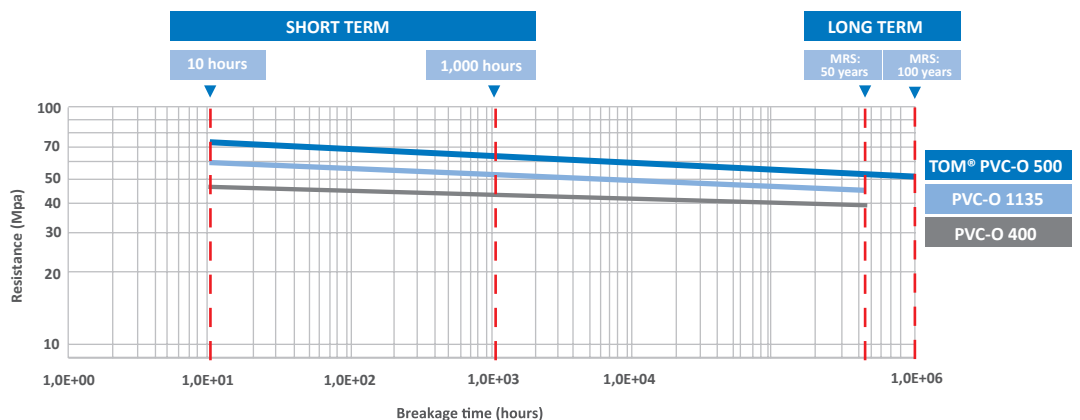

For the American Standards the class should be 1135, according to ASTM D 1483-12. The value is related to the Hydrostatic design Basis (HDB), tested at 104 hours and extrapolated to 105 hours. Class 1135 means that after 105 hours the material withstands at least 6810 psi (46.92MPa).

## MRS - Minimum Required Strength

The Minimum Required Strength (MRS) is determined by the materials degree of orientation and therefore is a key factor in order to determine the hydraulic design stress. The higher the MRS the longer useful life expected and the better guaranty for long term behavior.

## Overall service design coefficient: C

This variable takes into consideration service conditions as well as the properties of the piping system components. It goes from 1.25 to 2.0, being 1.25 the lowest overall service design coefficient allowed only for the French Standard NF T54-948:2010 and for the highest classes, 450 and 500.

## HDB - Hydraulic design stress

It is the estimated maximum tensile strength the material is capable of withstanding continuously with the confidence that pipe failure will not occur. It is related to the MRS and C by the following equation.

$$\sigma_s = \frac{\text{MRS}}{C}$$

## PVC-O vs. PVC-U

The substantial improvement of the **PVC-O's** mechanical properties due to **Molecular Orientation** results in a reduction of the material needs compared to PVC-U. The following chart compares the raw material needs for PVC-O and PVC-U according to different Standards.

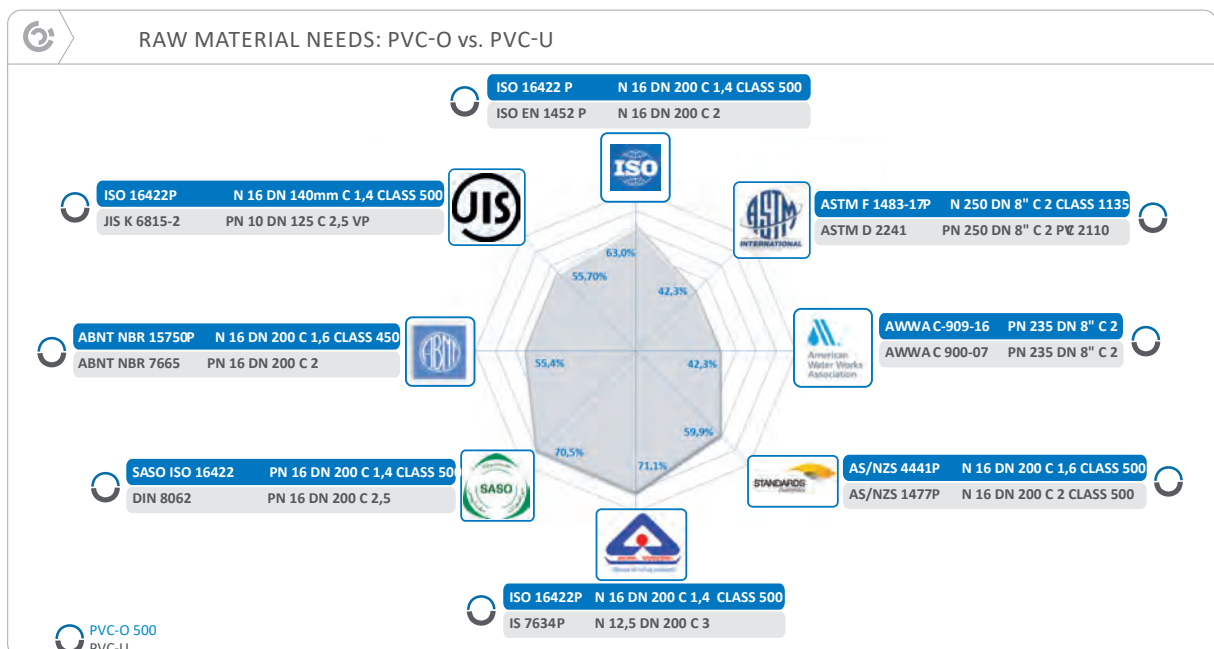

## Rework material

**Molecor systems** are very stable and robust. Therefore, the technology can perfectly work with rework material. Most of the Standards reviewed on the table on the preceding page allow the use of the manufacturer's own reprocessable material produced during the manufacture and testing of products.



### IPEX Inc. (Canada)

 IPEX, a company with more than 50 years of experience in plastic pipes manufacturing technologies, also uses the technology developed by Molecor to manufacture PVC-O pipes. This technology, together with efficient distribution centers and customer support, has made this company a reference in quality, innovation and performance.



Canada

### Molecor Headquarters (Spain)

Located in the industrial area of Madrid, only 40 minutes from the Barajas International Airport, Molecor has a manufacturing plant for PVC-O pipes and fittings, and also an industrial site to manufacture the machines for producing PVC-O pipes, taking advantage of these complementary points of view and learning from them. Molecor offers tailor made solutions to its customers adjusting its technology to their needs.



### Plásticos Rival (Ecuador)

 Rival, is a leader company with over 35 years of experience in manufacturing plastic pipes in Ecuador. As a result of its strategy, it completed its PVC, HDPE and GRP pipeline range with the most advanced technology for water solutions, the technology of Molecor, to manufacture PVC-O pipes. They are currently producing PVC-O pipes in their modern plant located in the city of Cuenca.

### Gerfor (Colombia)

 GERFOR is a multinational company, 100% Colombian, with a wide experience in production and trading of PVC pipes and fittings, taps, PVC slates and geosystems, with presence in various countries in South America and exporting its products to more than 10 countries in America. Since 2011, PVC-O pipes are being manufactured with the technology of Molecor.



Colombia



Ecuador

### Plastiferro (Argentina)

**PLASTIFERRO**  
FABRICANDO TUBOS PARA CONECTAR A LOS ARGENTINOS.

The technology developed by Molecor arrived in Argentina with Plastiferro in order to provide a qualitative change to the sector. With this technology, Plastiferro is able to manufacture PVC-O pipes of the highest Class and quality for the water networks.



Molecor Paraná arises from the alliance between Molecor and TOCSA with the aim of producing PVC-O pipes, unique product in the market, very advanced technologically and exclusive in the Southern Cone.

Paraguay



Argentina

### Molecor South Africa



Molecor decided to invest in this African country, forming a Joint Venture with the company Sizabantu Piping Systems (PTY) LTD. The factory is located in Richards Bay (KwaZulu-Natal region) and manufactures TOM® PVC-O pipes under the license of Molecor Tecnologia, for the Southern African countries.

The highest engineering capabilities in addition to a real production experience make of the Molecor system a brilliant, robust and reliable technological item. With its three areas of activity, pipes, fittings and technology manufacture, Molecor completes a circle of successful implementation achieving its vision of being a global leader in Molecular Orientation technologies through innovation and commitment.



### Coes Company (Italy)



COES COMPANY is composed by two historical firms that are working today in a sole big Company.

Since March 2010 they are manufacturing PVC-O pipes with the technology of Molecor. They obtained in a record time the NF mark certificate according to NF T54-948:2010 for the range of products DN 110-250 mm PN 16 bars.

Italy



Kazakhstan

### Ori-Plast Limited (India)



A pioneer in the pipes' field in India, Ori-Plast Ltd an established market leader and trusted piping brand across the country. Over the last five decades, Ori-Plast has kept its promise of delivering superior quality and providing complete piping solutions to millions of homes, industries and farmers and now, the company goes on providing users with the best solutions in Oriented PVC thanks to the technology of Molecor, incorporated into its manufacturing plant in 2019.

India

### Parvati Agro Plast (India)



Parvati is one largest leading manufacturers of Rigid PVC Pipe, HDPE, MDPE & Sewerage Pipes of various sizes & classes in India and, in order to cater the needs of the market from 2019 and uses also a new PVC-O pipeline developed with the Molecor technology to provide the Indian market with this outstanding product.

South Africa

### Chemfab Alkalis Limited (India)



Chemfab Alkalis Limited (CCAL) is a Company incorporated under the Companies Act, 1956; it was India's first Membrane Cell Caustic Soda Plant, state-of-the-art, pollution-free and energy conserving technology. CCAL, always interested in new and effective technologies, now manufactures Oriented PVC pipes with the exclusive technology developed by Molecor.

### Moletech Astana (Kazakhstan)



Pipe manufacturing facility of Moletech Astana started in 2016 its activity in the capital of the Republic of Kazakhstan, Astana-city. The plant, in which PVC-O pipes are manufactured with the technology of Molecor, participates in various pipeline projects of water supply, irrigation, reclaimed water and other applications in Kazakhstan and other countries of the region.

### Floking Pipes Pvt Ltd (India)



Floking Pipes Pvt. Ltd. is promoted by Electro Group of Companies and Modi Group of Companies. Equipped with the ground-breaking technology developed by Molecor, Floking Pipes becomes the first PVC-O pipe manufacturer and is ready to revolutionize the PVC-O pipe segment in India.

### Molecor SEA (Malaysia)



Molecor (SEA) was incorporated in 2013 to manufacture and distribute PVC-O pipes in South East Asia. We are committed to manufacturing and delivering products and services of the highest possible quality, on time, guaranteeing to meet or exceed the customer's expectations at the most economical level.

Malaysia

Australia

### Pipemakers (Australia)



Pipemakers Australia is a leading manufacturer and supplier of PVC piping to the construction and building industry. The Australian company, committed to the latest modern practices, incorporated the technology developed by Molecor in order to provide the most advanced solutions for water transport, manufacturing PVC-O pipes since June 2014.

### M-OR-P 1640

#### LAY-OUT

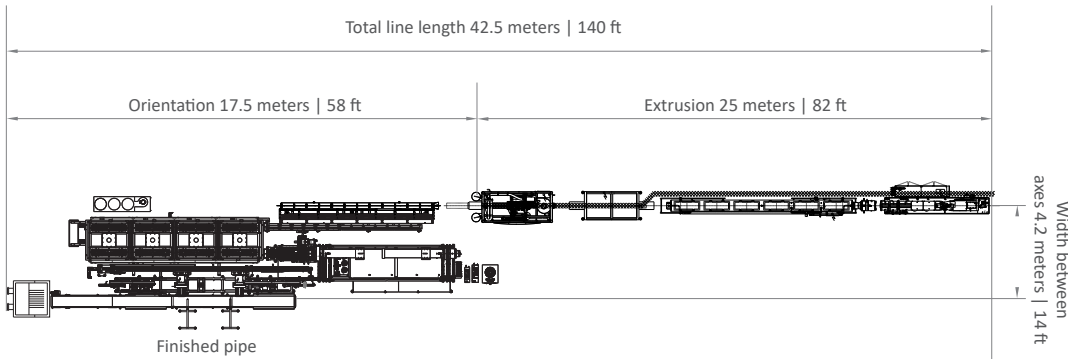

**RANGE OF PRODUCTS:**  
DN90 to 400 mm  
(4" to 14")  
PN up to 25 bar  
(365 psi) or 305 psi  
(21 bar)

**RECOMMENDED EXTRUSION LINE:**  
ARGOS 93, PH4,  
PH5

battenfeld-cincinnati

**OUTPUT:**  
3,000 Tons/year

### M-OR-P 2063

#### LAY-OUT

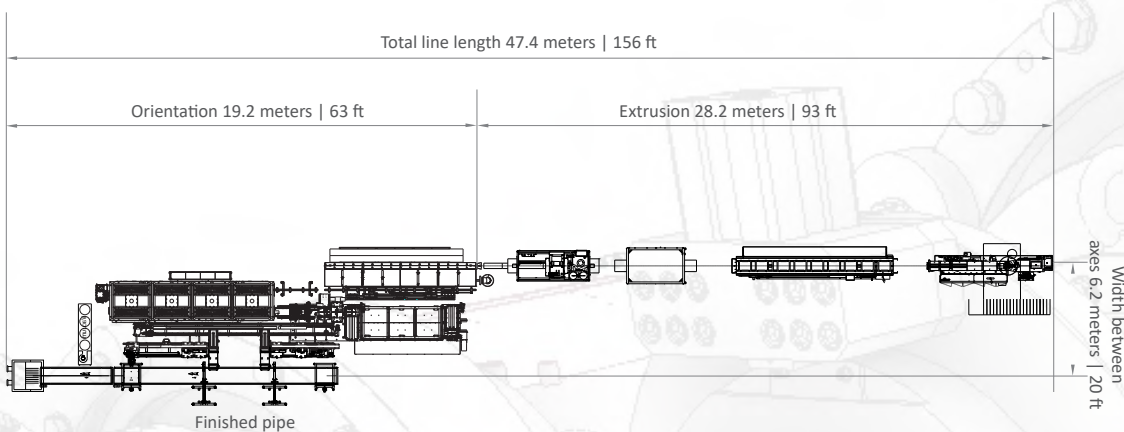

**RANGE OF PRODUCTS:**  
DN200 to 630 mm  
(8" to 24")  
PN up to 25 bar  
(365 psi) or 305 psi  
(21 bar)

**RECOMMENDED EXTRUSION LINE:**  
ARGOS 93, PH4,  
PH5

battenfeld-cincinnati

**OUTPUT:**  
5,000 Tons/year

**Cutting-edge technology to manufacture the widest range of PVC-O pipes in the world**

**M-OR-P 1640**

EN	ISO	AS/NZS	ASTM		AWWA	CSA		NBR	SASO ISO
17176	16422	4441	1483-05		909-09	B137.3.1		15750	16422
DN mm	DN mm	DN mm	DN inch		DN inch	DN inch		DN mm	DN mm
			IPS	CIOD	CIOD	IPS	CIOD		
90	90	80							90
110	110	100	4"	4"	4"	4"	4"	100	110
125	125								125
140	140								140
160	160	150	6"	6"	6"	6"	6"	150	160
180	180								180
200	200		8"		8"	8"	8"	200	200
225	225	200		8"	8"		8"	200	225
250	250	225							250
280	280	250	10"	10"	10"	10"	10"	250	280
315	315								315
		300	12"	12"	12"	12"	12"	300	
355	355		14"		14"	14"	14"	350	355
400	400		14"	14"	14"	14"	14"	350	400

**M-OR-P 2063**

EN	ISO	AS/NZS	ASTM		AWWA	CSA		NBR	SASO ISO
17176	16422	4441	1483-05		909-09	B137.3.1		15750	16422
DN mm	DN mm	DN mm	DN inch		DN inch	DN inch		DN mm	DN mm
			IPS	CIOD	CIOD	IPS	CIOD		
200	200		8"			8"			200
250	250	250		8"	8"	10"	8"	200	250
280	280		10"	10"	10"		10"	250	280
315	315		12"			12"		300	315
355	355	300	14"	12"	12"	14"	12"		355
400	400	375	16"	14"	14"	16"	14"	350	400
450	450		18"	16"	16"	18"	16"	400	450
500	500	450	20"	18"	18"	20"	18"	450	500
560	560	500		20"	20"		20"	500	560
		560	24"			24"			
		600	24"	24"			24"		
630	630				24"		24"	600	630

The range of products highlighted in blue are special adaptation processed under request. The diameters in blue are not contemplated in the standards.

### M-OR-P 3163

#### LAY-OUT

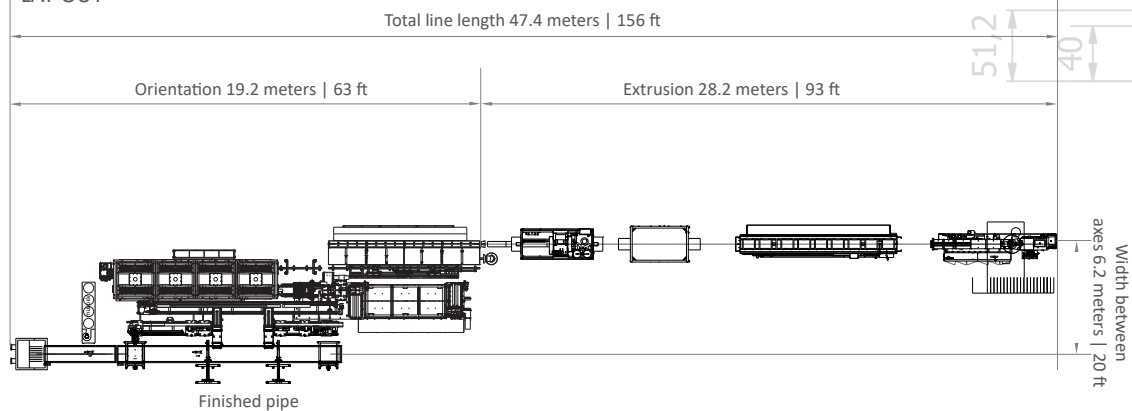

**RANGE OF PRODUCTS:**  
DN200 to 630 mm  
(8" to 24")  
PN up to 25 bar  
(365 psi) or 305 psi  
(21 bar)

**RECOMMENDED EXTRUSION LINE:**  
ARGOS 93, PH4,  
PH5

battelfeld-cincinnati

**OUTPUT:**  
5,000 Tons/year

### M-OR-P 3180

#### LAY-OUT

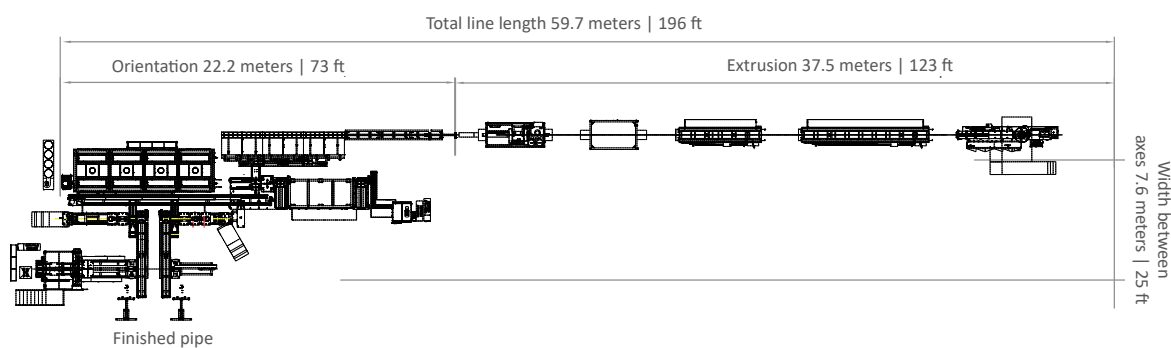

**RANGE OF PRODUCTS:**  
DN315 mm to 800 mm  
(12" to 30") PN up to  
25 bar (365 psi) or 305  
psi (21 bar)

**RECOMMENDED EXTRUSION LINE:**  
ARGOS 135, PH5 a PH7

battelfeld-cincinnati

**OUTPUT:**  
6,000 Tons / year

### M-OR-P 5012

#### LAY-OUT

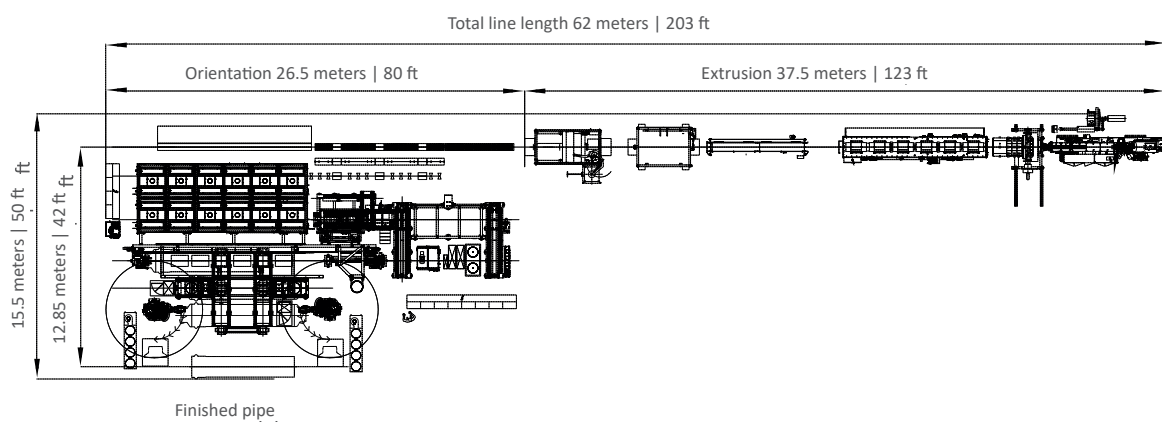

**RANGE OF PRODUCTS:**  
DN500 mm to 1200  
mm (18" to 48") PN up  
to 25 bar (365 psi) or  
305 psi (21 bar)

**RECOMMENDED EXTRUSION LINE:**  
ARGOS 135, PH5 a PH7

battelfeld-cincinnati

**OUTPUT:**  
7,000 Tons / year



M-OR-P 3163									
EN	ISO	AS/NZS	ASTM		AWWA	CSA		NBR	SASO ISO
17176	16422	4441	1483-05		909-09	B137.3.1		15750	16422
DN mm	DN mm	DN mm	DN inch		DN inch	DN inch		DN mm	DN mm
			IPS	CIOD	CIOD	IPS	CIOD		
250	250	250	10"	10"	10"	10"	10"	250	250
280	280								280
315	315	300	12"	12"	12"	12"	12"	300	315
355	355		14"	14"	14"	14"	14"		355
400	400	375	16"	16"	16"	16"	16"	400	400
450	450		18"	18"	18"	18"	18"		450
500	500	450	20"	20"	20"	20"	20"	450	500
560	560		500	20"	20"	20"	20"		560
630	630	560	24"		24"	24"	24"	600	630
		600	24"	24"					

M-OR-P 3180									
EN	ISO	AS/NZS	ASTM		AWWA	CSA		NBR	SASO ISO
17176	16422	4441	1483-05		909-09	B137.3.1		15750	16422
DN mm	DN mm	DN mm	DN inch		DN inch	DN inch		DN mm	DN mm
			IPS	CIOD	CIOD	IPS	CIOD		
315	315	300	12"	12"	12"	12"	12"	300	315
355	355		14"	14"	14"	14"	14"		355
400	400	375	16"	16"	16"	16"	16"	400	400
450	450		18"	18"	18"	18"	18"		450
500	500	450	20"	20"	20"	20"	20"	450	500
560	560		500	20"	20"	20"	20"		560
630	630	560	24"		24"	24"	24"	600	630
		600	24"	24"					
710	710	750	28"	26"	26"	28"	26"	710	710
800	800		30"	30"	30"	30"	30"		800

M-OR-P 5012									
EN	ISO	AS/NZS	ASTM		AWWA	CSA		NBR	SASO ISO
17176	16422	4441	1483-05		909-09	B137.3.1		15750	16422
DN mm	DN mm	DN mm	DN inch		DN inch	DN inch		DN mm	DN mm
			IPS	CIOD	CIOD	IPS	CIOD		
500	500	500	20"	18"	18"	20"	18"	500	500
560	560		20"	20"	20"	20"	20"		560
630	630	600	24"		24"	24"	24"	600	630
710	710		24"	24"	24"	24"	24"		710
800	800	750	28"	26"	26"	28"	26"	710	800
			30"	30"	30"	30"	30"		
900	900	800	32"	30"	30"	32"	30"	800	900
1000	1000		36"	34"	34"	36"	34"		900
1100	1100	900	40"	38"	38"	40"	38"	900	1000
1200	1200		42"	40"	40"	42"	40"		1100
		1000	42"	40"	40"	42"	40"	1100	1100
		1100	48"	42"	42"	48"	42"	1100	1200
		1100	48"	42"	42"	48"	42"	1200	1200

The range of products highlighted in blue are special adaptation processed under request. The diameters in blue are not contemplated in the standards.

## Notes

A series of horizontal dotted lines for writing notes, spanning most of the page width.







Licensees



Reputed partners



Supported by

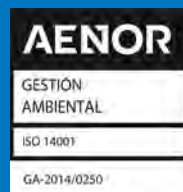
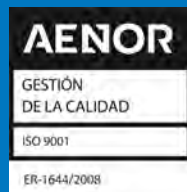

MOLECOR  
Ctra. M-206 Torrejón-Loeches Km 3.1 - 28890 Loeches, Madrid, Spain  
T: + 34 911 337 088 | F: + 34 916 682 884

SANECOR AR EVAC+

T. + 34 949 801 459  
F. + 34 949 297 409

TOM Technology

T. +34 911 337 088  
F. + 34 916 682 884

sac@molecor.com

www.molecor.com

info@molecor.com

